

**Concourse A, Upper Level**

**Concession Category**

- FoodService
- ConvenienceRetail
- SpecialtyRetail
- Vending
- Services
- SupportSpace
- MAA Controlled

**Vending Machine Type**

- |   |   |
|---|---|
| <span style="color: green;">◆</span> Automated Teller Machine | <span style="color: blue;">●</span> Water     |
| <span style="color: red;">◆</span> Lottery                    | <span style="color: purple;">●</span> Snack   |
| <span style="color: blue;">■</span> Tech                      | <span style="color: grey;">○</span> Ice Cream |
| <span style="color: purple;">■</span> Phone/SIM               | <span style="color: pink;">▲</span> Cosmetics |
| <span style="color: orange;">■</span> FuelRod                 | <span style="color: green;">▲</span> Flowers  |
| <span style="color: teal;">●</span> Beverage                  | <span style="color: orange;">●</span> PPE     |

**Location**

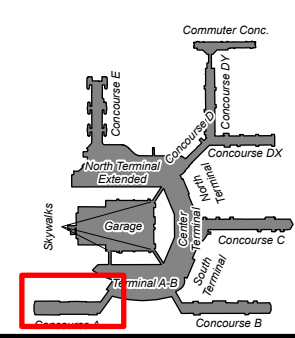

Date: 2021-12-14



**RFP-MDOT-AC-2023**

**Exhibit E**

**Concession Operational and Storage Areas**

**Sheet 1 of 11**

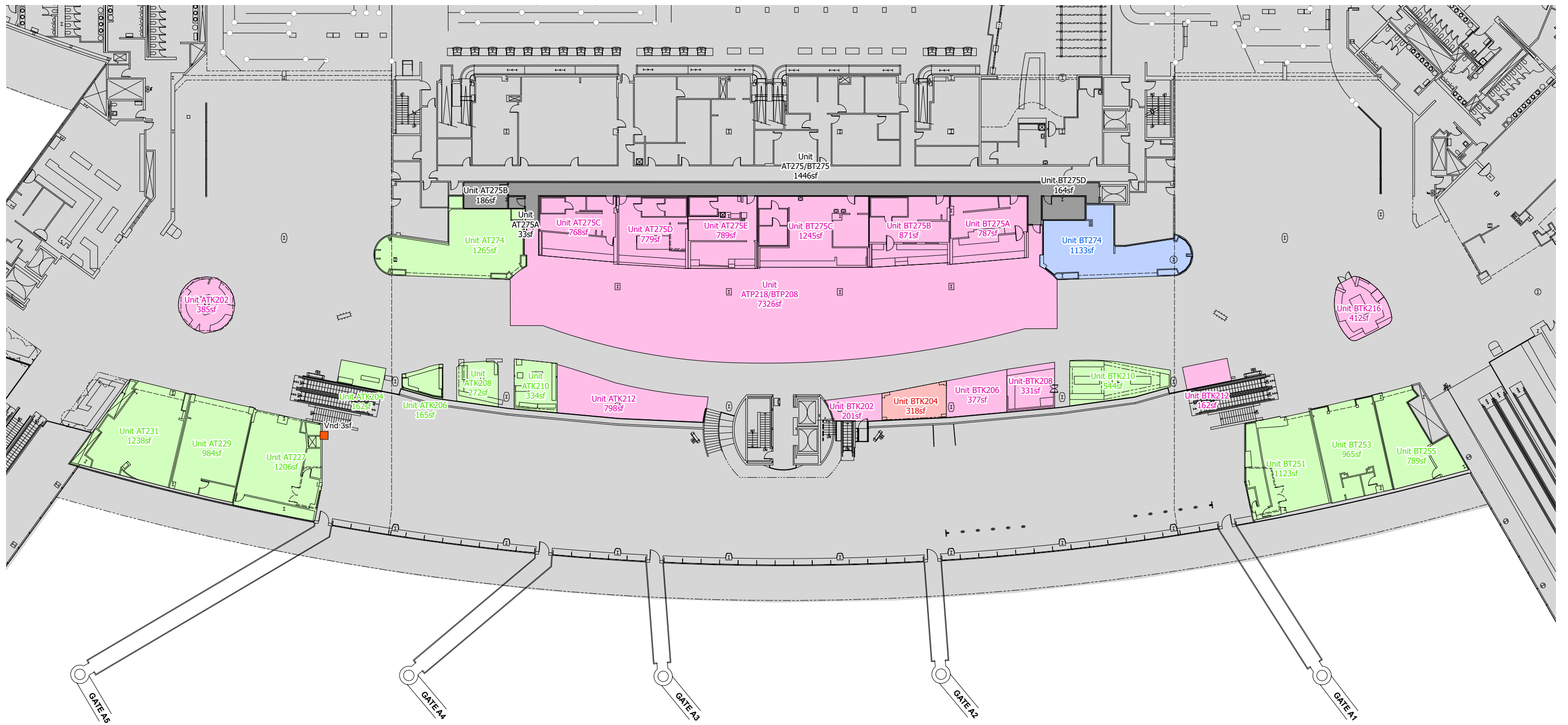

A/B Core, Upper Level

**Concession Category**

- FoodService
- ConvenienceRetail
- SpecialtyRetail
- Vending
- Services
- SupportSpace
- MAA Controlled

**Vending Machine Type**

- |   |   |
|---|---|
| <span style="color: green;">◆</span> Automated Teller Machine | <span style="color: blue;">●</span> Water     |
| <span style="color: red;">◆</span> Lottery                    | <span style="color: purple;">●</span> Snack   |
| <span style="color: blue;">■</span> Tech                      | <span style="color: grey;">○</span> Ice Cream |
| <span style="color: purple;">■</span> Phone/SIM               | <span style="color: pink;">▲</span> Cosmetics |
| <span style="color: orange;">■</span> FuelRod                 | <span style="color: green;">▲</span> Flowers  |
| <span style="color: teal;">●</span> Beverage                  | <span style="color: orange;">◆</span> PPE     |

Location

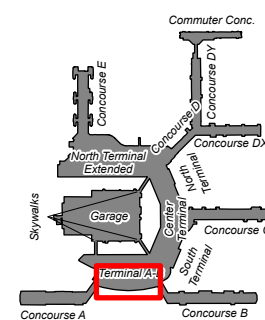

Date: 2021-12-14



RFP-MDOT-AC-2023

**Exhibit E**

**Concession Operational and Storage Areas**

Sheet 2 of 11

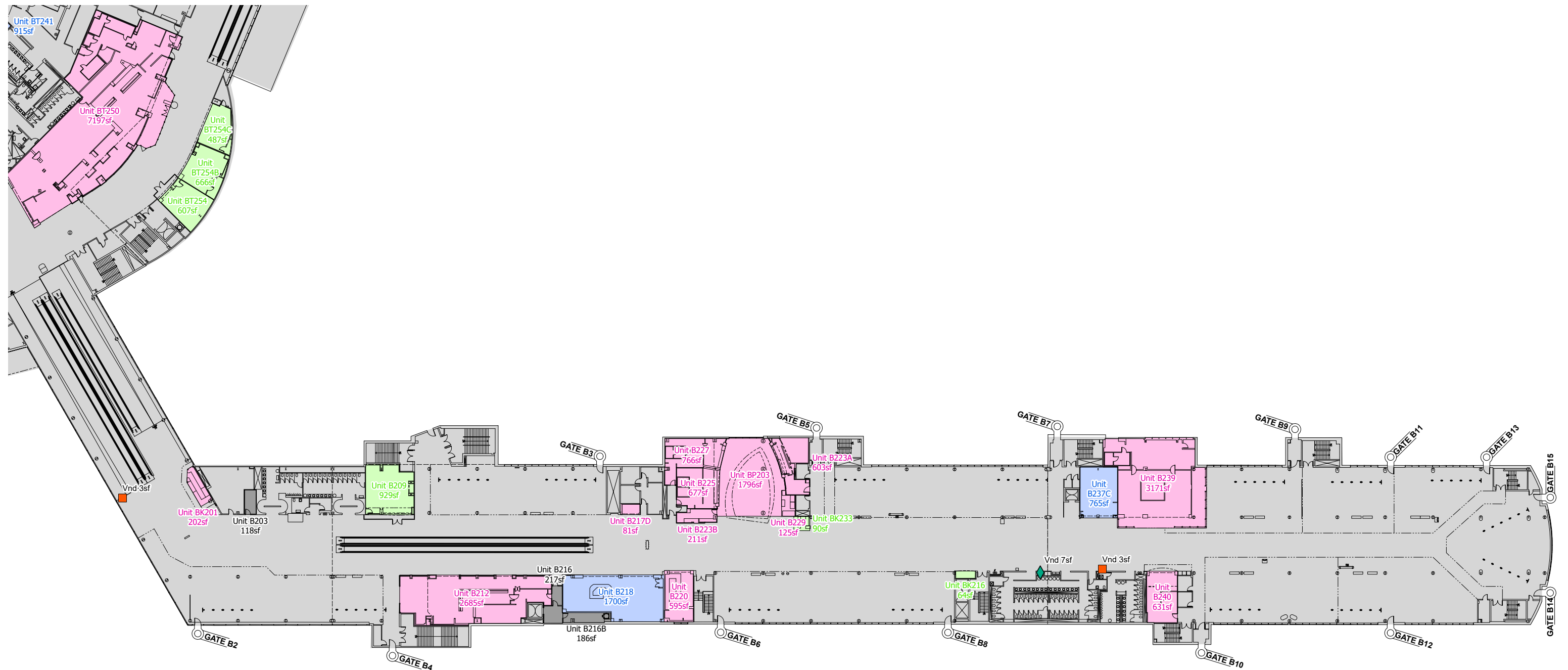

**Concourse B, Upper Level**

**Concession Category**

- FoodService
- ConvenienceRetail
- SpecialtyRetail
- Vending
- Services
- SupportSpace
- MAA Controlled

**Vending Machine Type**

- Automated Teller Machine
- Lottery
- Tech
- Phone/SIM
- FuelRod
- Beverage
- Water
- Snack
- Ice Cream
- Cosmetics
- Flowers
- PPE

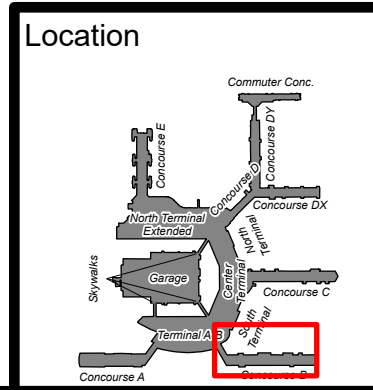

Date: 2021-12-14



**RFP-MDOT-AC-2023**  
**Exhibit E**  
**Concession Operational and Storage Areas**  
**Sheet 3 of 11**

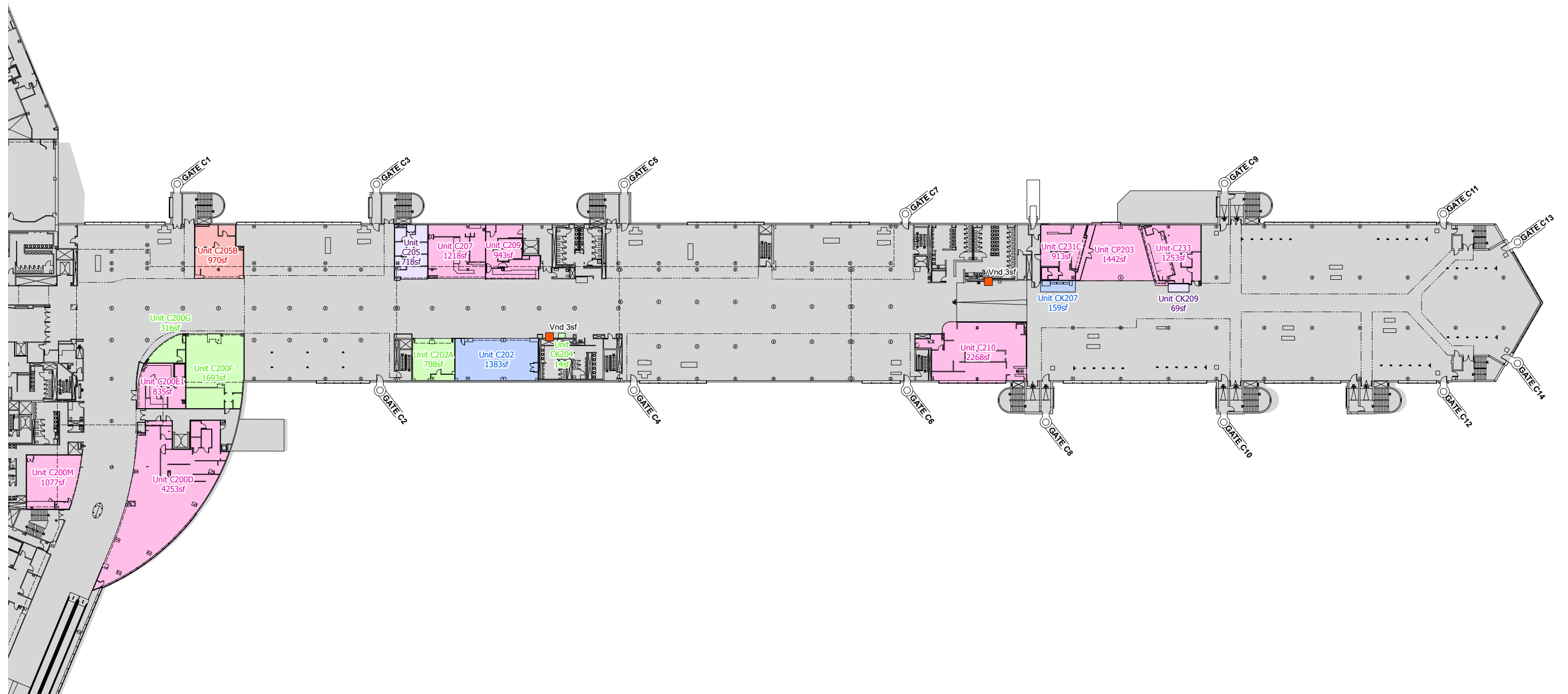

**Concourse C, Upper Level**

**Concession Category**

- FoodService
- ConvenienceRetail
- SpecialtyRetail
- Vending
- Services
- SupportSpace
- MAA Controlled

**Vending Machine Type**

- Automated Teller Machine
- Lottery
- Tech
- Phone/SIM
- FuelRod
- Beverage
- Water
- Snack
- Ice Cream
- Cosmetics
- Flowers
- PPE

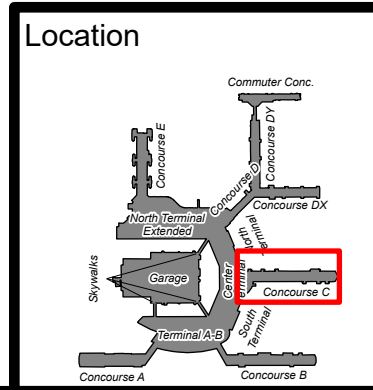

Date: 2021-12-14



**RFP-MDOT-AC-2023**  
**Exhibit E**  
**Concession Operational and Storage Areas**  
 Sheet 4 of 11



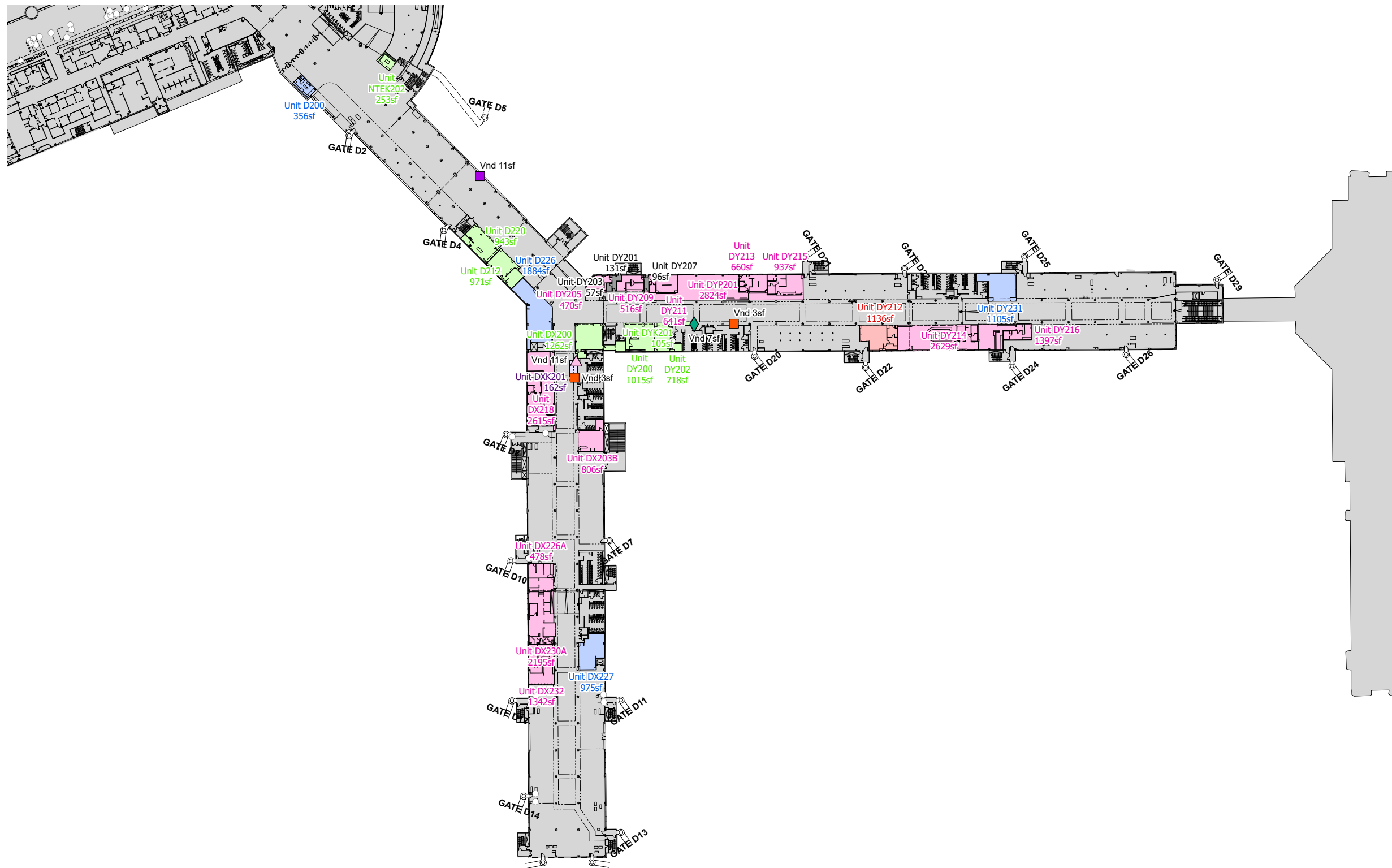

**Concourse D, Upper Level**

**Concession Category**

- FoodService
- ConvenienceRetail
- SpecialtyRetail
- Vending
- Services
- SupportSpace
- MAA Controlled

**Vending Machine Type**

- Automated Teller Machine
- Lottery
- Tech
- Phone/SIM
- FuelRod
- Beverage
- Water
- Snack
- Ice Cream
- Cosmetics
- Flowers
- PPE

**Location**

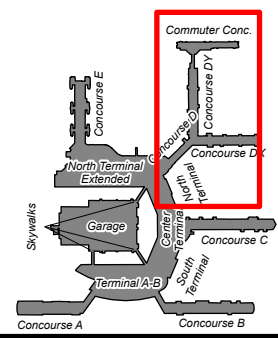

Date: 2021-12-14



**RFP-MDOT-AC-2023**  
**Exhibit E**  
**Concession Operational and Storage Areas**

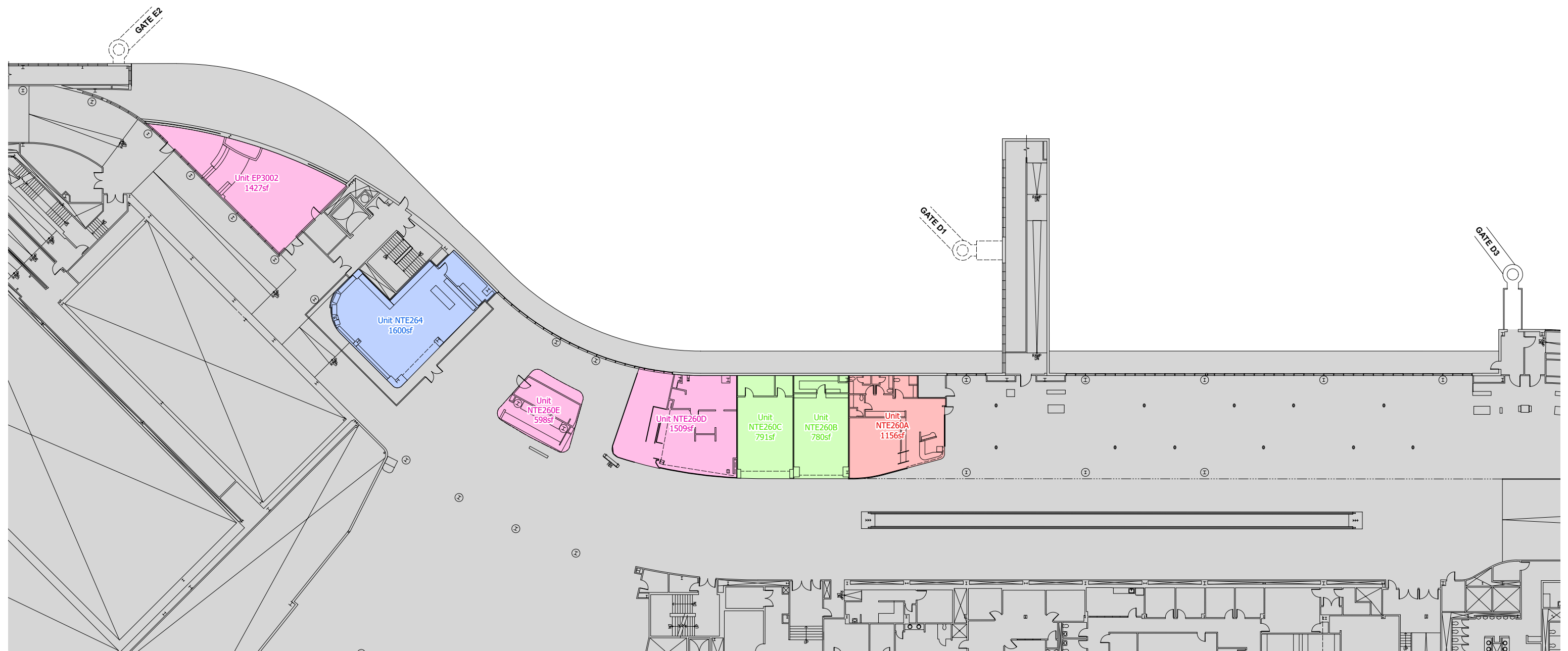

D/E Core, Upper Level

**Concession Category**

- FoodService
- ConvenienceRetail
- SpecialtyRetail
- Vending
- Services
- SupportSpace
- MAA Controlled

**Vending Machine Type**

- |  |   |
|--|---|
| <span style="color: blue;">◆</span> Automated Teller Machine | <span style="color: blue;">●</span> Water     |
| <span style="color: red;">◆</span> Lottery                   | <span style="color: purple;">●</span> Snack   |
| <span style="color: blue;">■</span> Tech                     | <span style="color: grey;">○</span> Ice Cream |
| <span style="color: purple;">■</span> Phone/SIM              | <span style="color: grey;">△</span> Cosmetics |
| <span style="color: orange;">■</span> FuelRod                | <span style="color: green;">▲</span> Flowers  |
| <span style="color: green;">●</span> Beverage                | <span style="color: orange;">●</span> PPE     |

**Location**

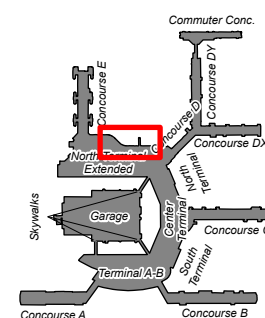

Date: 2021-12-14



RFP-MDOT-AC-2023

**Exhibit E**

**Concession Operational and Storage Areas**

Sheet 6 of 11

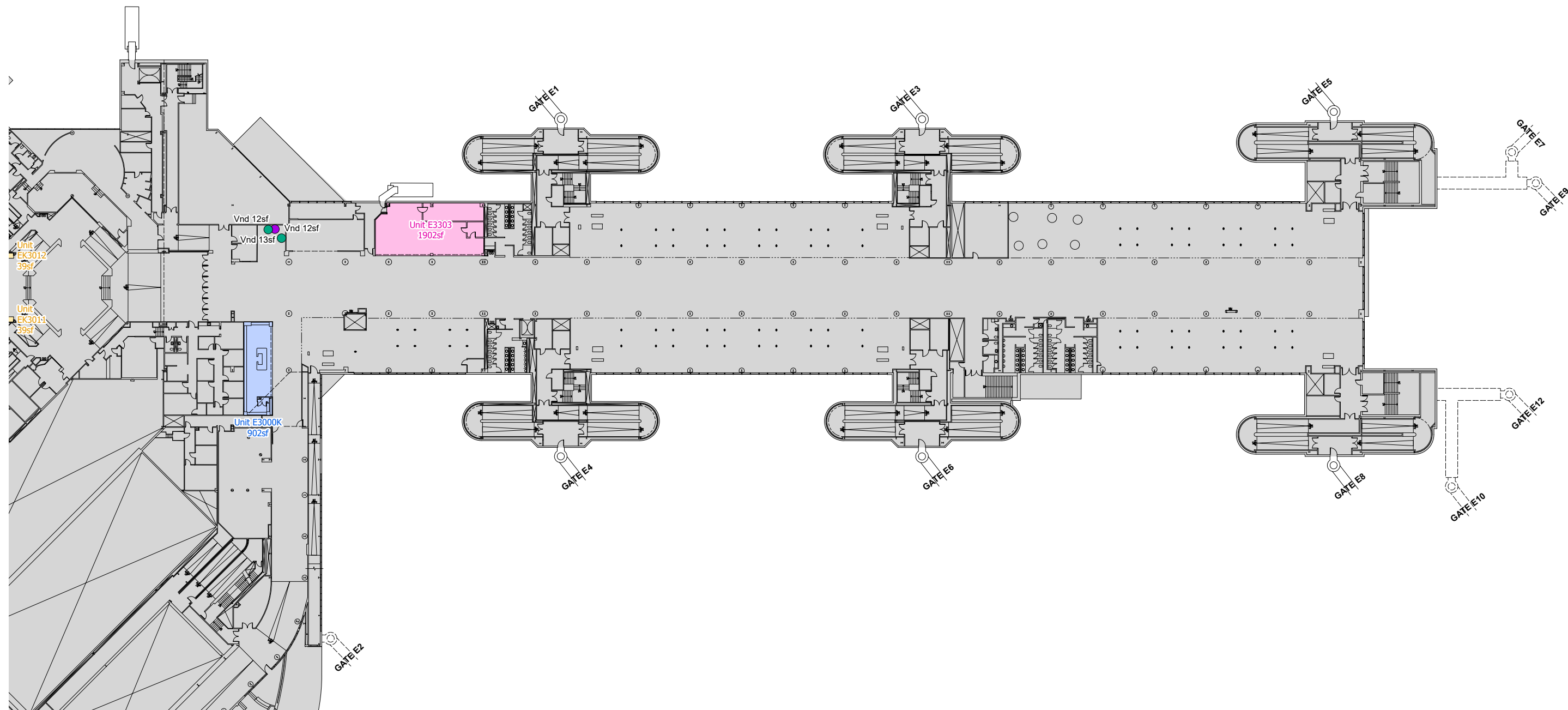

**Concourse E, Upper Level**

**Concession Category**

- FoodService
- ConvenienceRetail
- SpecialtyRetail
- Vending
- Services
- SupportSpace
- MAA Controlled

**Vending Machine Type**

- |   |  |
|---|--|
| <span style="display: inline-block; width: 10px; height: 10px; border: 1px solid black; background-color: #90EE90; margin-right: 5px;"></span> Automated Teller Machine | <span style="display: inline-block; width: 10px; height: 10px; background-color: #ADD8E6; border: 1px solid black; margin-right: 5px;"></span> Water |
| <span style="display: inline-block; width: 10px; height: 10px; border: 1px solid black; background-color: #FFC0CB; margin-right: 5px;"></span> Lottery                  | <span style="display: inline-block; width: 10px; height: 10px; background-color: #FF69B4; border: 1px solid black; margin-right: 5px;"></span> Snack |
| <span style="display: inline-block; width: 10px; height: 10px; background-color: #0000FF; border: 1px solid black; margin-right: 5px;"></span> Tech                     | <span style="display: inline-block; width: 10px; height: 10px; border: 1px solid black; margin-right: 5px;"></span> Ice Cream                        |
| <span style="display: inline-block; width: 10px; height: 10px; background-color: #800080; border: 1px solid black; margin-right: 5px;"></span> Phone/SIM                | <span style="display: inline-block; width: 10px; height: 10px; border: 1px solid black; margin-right: 5px;"></span> Cosmetics                        |
| <span style="display: inline-block; width: 10px; height: 10px; background-color: #FF8C00; border: 1px solid black; margin-right: 5px;"></span> FuelRod                  | <span style="display: inline-block; width: 10px; height: 10px; border: 1px solid black; margin-right: 5px;"></span> Flowers                          |
| <span style="display: inline-block; width: 10px; height: 10px; background-color: #008000; border: 1px solid black; margin-right: 5px;"></span> Beverage                 | <span style="display: inline-block; width: 10px; height: 10px; border: 1px solid black; margin-right: 5px;"></span> PPE                              |

**Location**

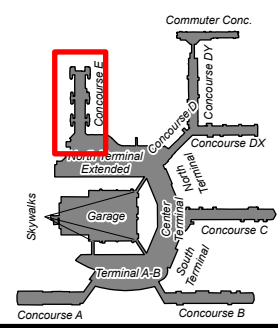

Date: 2021-12-14



**RFP-MDOT-AC-2023**  
**Exhibit E**  
**Concession Operational and Storage Areas**  
 Sheet 7 of 11

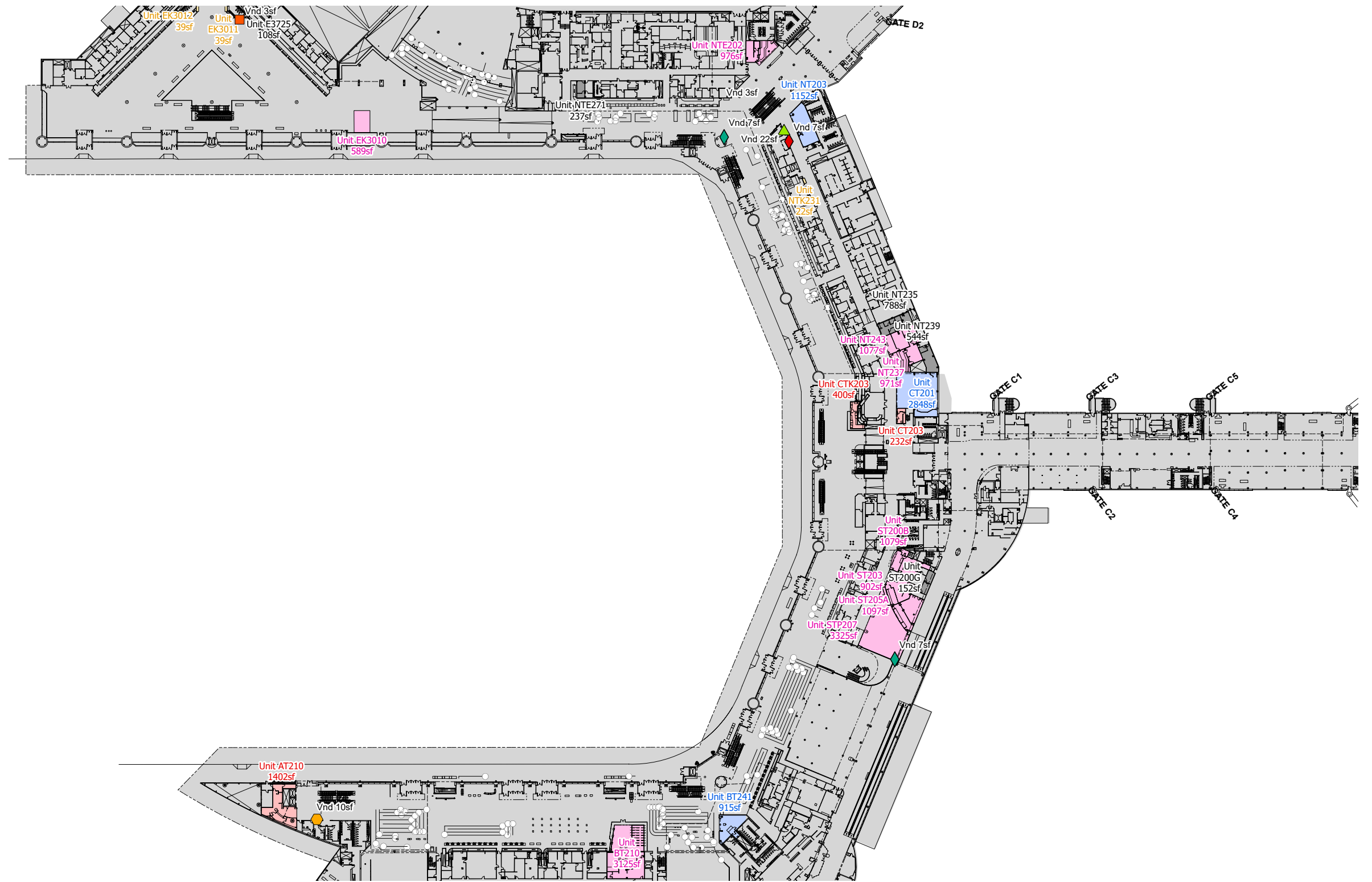

**Main Terminal, Upper Level**

**Concession Category**

- FoodService
- ConvenienceRetail
- SpecialtyRetail
- Vending
- Services
- SupportSpace
- MAA Controlled

**Vending Machine Type**

- |  |   |
|--|---|
| <span style="display: inline-block; width: 10px; height: 10px; border: 1px solid green; margin-right: 5px;"></span> Automated Teller Machine | <span style="display: inline-block; width: 10px; height: 10px; border: 1px solid blue; margin-right: 5px;"></span> Water      |
| <span style="display: inline-block; width: 10px; height: 10px; border: 1px solid red; margin-right: 5px;"></span> Lottery                    | <span style="display: inline-block; width: 10px; height: 10px; border: 1px solid purple; margin-right: 5px;"></span> Snack    |
| <span style="display: inline-block; width: 10px; height: 10px; background-color: blue; margin-right: 5px;"></span> Tech                      | <span style="display: inline-block; width: 10px; height: 10px; border: 1px solid white; margin-right: 5px;"></span> Ice Cream |
| <span style="display: inline-block; width: 10px; height: 10px; background-color: purple; margin-right: 5px;"></span> Phone/SIM               | <span style="display: inline-block; width: 10px; height: 10px; border: 1px solid pink; margin-right: 5px;"></span> Cosmetics  |
| <span style="display: inline-block; width: 10px; height: 10px; background-color: orange; margin-right: 5px;"></span> FuelRod                 | <span style="display: inline-block; width: 10px; height: 10px; border: 1px solid green; margin-right: 5px;"></span> Flowers   |
| <span style="display: inline-block; width: 10px; height: 10px; border: 1px solid green; margin-right: 5px;"></span> Beverage                 | <span style="display: inline-block; width: 10px; height: 10px; border: 1px solid yellow; margin-right: 5px;"></span> PPE      |

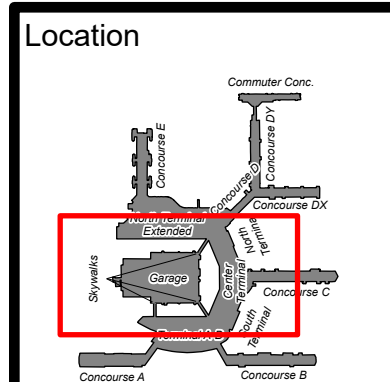

Date: 2021-12-14



**RFP-MDOT-AC-2023**  
**Exhibit E**  
**Concession Operational and Storage Areas**

**Sheet 8 of 11**



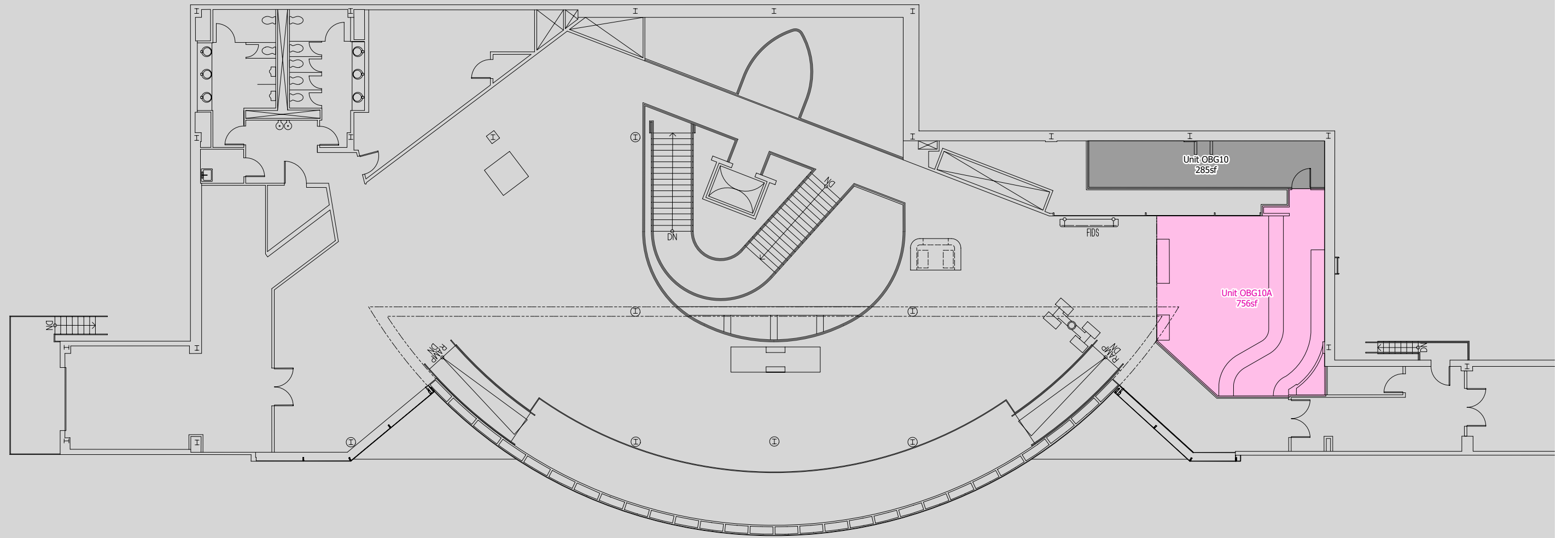

**Concession Category**

- FoodService
- ConvenienceRetail
- SpecialtyRetail
- Vending
- Services
- SupportSpace
- MAA Controlled

**Vending Machine Type**

- |   |   |
|---|---|
| <span style="display: inline-block; width: 10px; height: 10px; border: 1px solid black; background-color: #008000; transform: rotate(45deg); margin-right: 5px;"></span> Automated Teller Machine | <span style="display: inline-block; width: 10px; height: 10px; background-color: #0000FF; border-radius: 50%; margin-right: 5px;"></span> Water         |
| <span style="display: inline-block; width: 10px; height: 10px; border: 1px solid black; background-color: #FF0000; transform: rotate(45deg); margin-right: 5px;"></span> Lottery                  | <span style="display: inline-block; width: 10px; height: 10px; background-color: #800080; border-radius: 50%; margin-right: 5px;"></span> Snack         |
| <span style="display: inline-block; width: 10px; height: 10px; background-color: #0000FF; margin-right: 5px;"></span> Tech  | <span style="display: inline-block; width: 10px; height: 10px; border: 1px solid black; border-radius: 50%; margin-right: 5px;"></span> Ice Cream       |
| <span style="display: inline-block; width: 10px; height: 10px; background-color: #800080; margin-right: 5px;"></span> Phone/SIM   | <span style="display: inline-block; width: 10px; height: 10px; border: 1px solid black; transform: rotate(45deg); margin-right: 5px;"></span> Cosmetics |
| <span style="display: inline-block; width: 10px; height: 10px; background-color: #FF4500; margin-right: 5px;"></span> FuelRod   | <span style="display: inline-block; width: 10px; height: 10px; background-color: #32CD32; margin-right: 5px;"></span> Flowers                           |
| <span style="display: inline-block; width: 10px; height: 10px; background-color: #008000; border-radius: 50%; margin-right: 5px;"></span> Beverage  | <span style="display: inline-block; width: 10px; height: 10px; background-color: #FFA500; border-radius: 50%; margin-right: 5px;"></span> PPE           |

**Location**

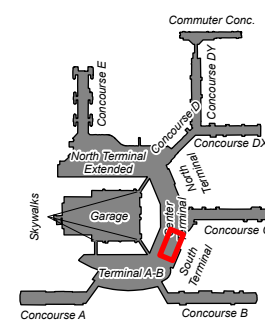

Date: 2021-12-14

**Terminal Observation Gallery, Observation Level**



**RFP-MDOT-AC-2023**  
**Exhibit E**  
**Concession Operational and Storage Areas**

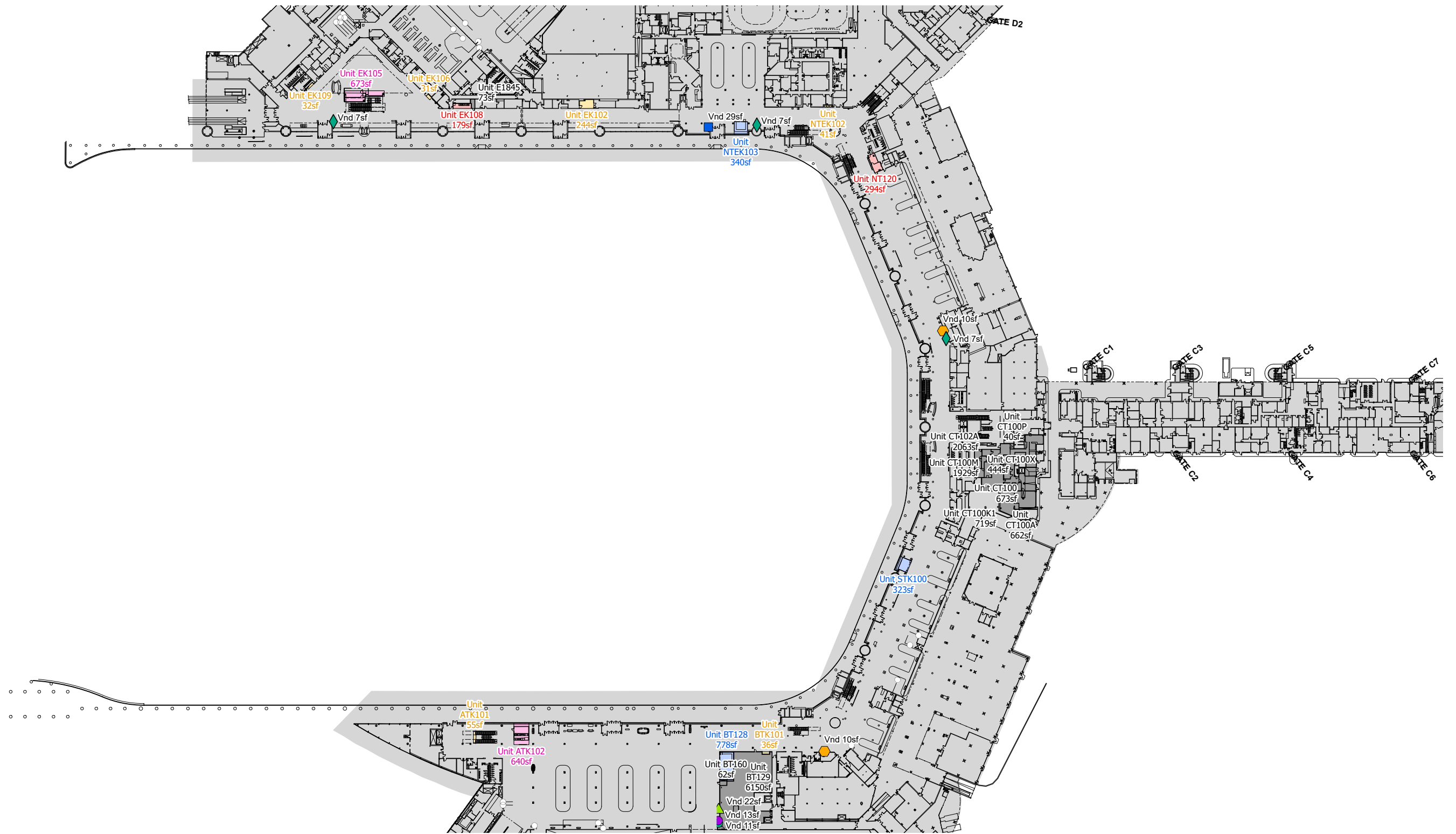

Main Terminal, Lower Level

**Concession Category**

- FoodService
- ConvenienceRetail
- SpecialtyRetail
- Vending
- Services
- SupportSpace
- MAA Controlled

**Vending Machine Type**

- |  |   |
|--|---|
| <span style="color: blue;">◆</span> Automated Teller Machine | <span style="color: blue;">●</span> Water     |
| <span style="color: red;">◆</span> Lottery                   | <span style="color: purple;">●</span> Snack   |
| <span style="color: blue;">■</span> Tech                     | <span style="color: grey;">○</span> Ice Cream |
| <span style="color: purple;">■</span> Phone/SIM              | <span style="color: grey;">△</span> Cosmetics |
| <span style="color: orange;">■</span> FuelRod                | <span style="color: green;">▲</span> Flowers  |
| <span style="color: green;">●</span> Beverage                | <span style="color: orange;">●</span> PPE     |

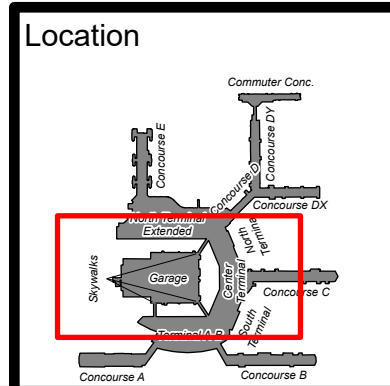

Date: 2021-12-14



**RFP-MDOT-AC-2023**  
**Exhibit E**  
**Concession Operational and Storage Areas**  
 Sheet 10 of 11

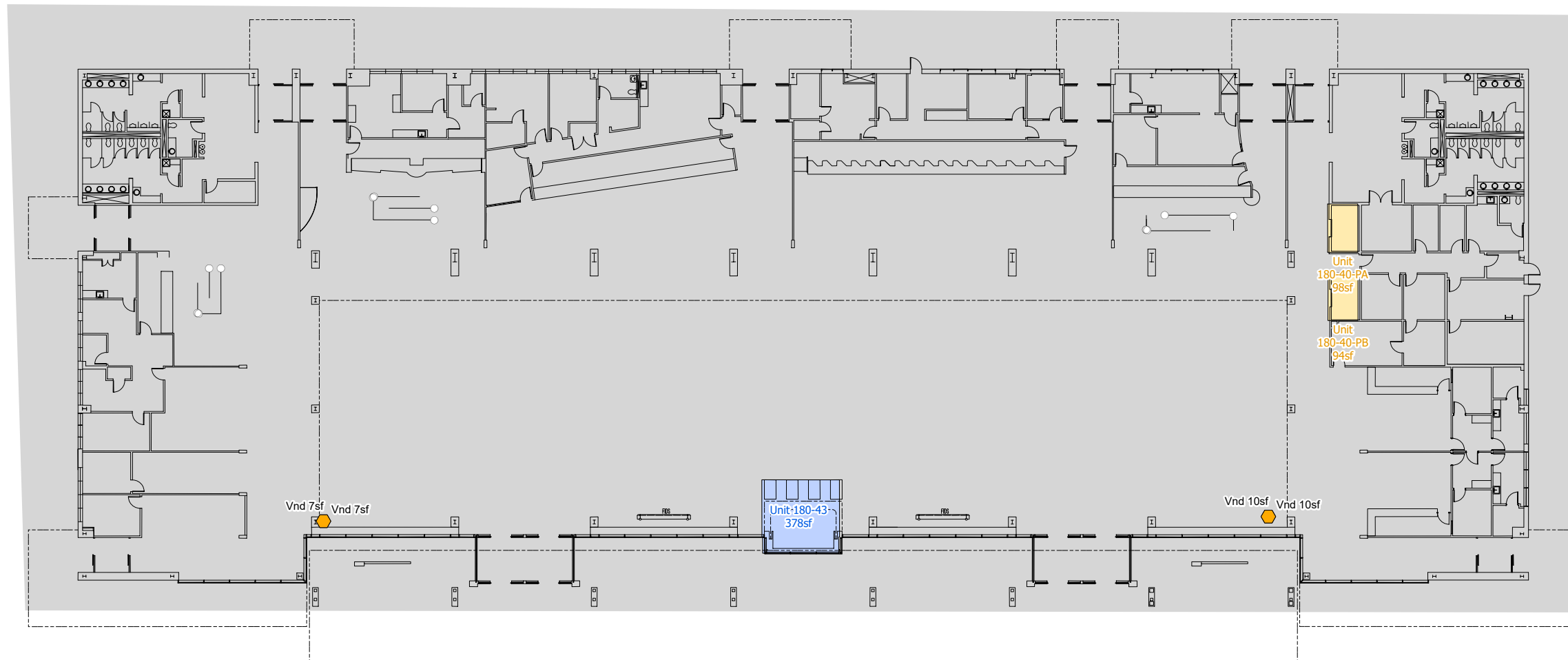

**Concession Category**

- FoodService
- ConvenienceRetail
- SpecialtyRetail
- Vending
- Services
- SupportSpace
- MAA Controlled

**Vending Machine Type**

- |   |  |
|---|--|
| <ul style="list-style-type: none"> <li><span style="display: inline-block; width: 10px; height: 10px; border: 1px solid black; background-color: #90EE90; margin-right: 5px;"></span> Automated Teller Machine</li> <li><span style="display: inline-block; width: 10px; height: 10px; border: 1px solid black; background-color: #FF4500; margin-right: 5px;"></span> Lottery</li> <li><span style="display: inline-block; width: 10px; height: 10px; border: 1px solid black; background-color: #0000FF; margin-right: 5px;"></span> Tech</li> <li><span style="display: inline-block; width: 10px; height: 10px; border: 1px solid black; background-color: #800080; margin-right: 5px;"></span> Phone/SIM</li> <li><span style="display: inline-block; width: 10px; height: 10px; border: 1px solid black; background-color: #FF4500; margin-right: 5px;"></span> FuelRod</li> <li><span style="display: inline-block; width: 10px; height: 10px; border: 1px solid black; background-color: #008000; margin-right: 5px;"></span> Beverage</li> </ul> | <ul style="list-style-type: none"> <li><span style="display: inline-block; width: 10px; height: 10px; border: 1px solid black; background-color: #0000FF; margin-right: 5px;"></span> Water</li> <li><span style="display: inline-block; width: 10px; height: 10px; border: 1px solid black; background-color: #800080; margin-right: 5px;"></span> Snack</li> <li><span style="display: inline-block; width: 10px; height: 10px; border: 1px solid black; background-color: #FFFFFF; border-radius: 50%; margin-right: 5px;"></span> Ice Cream</li> <li><span style="display: inline-block; width: 10px; height: 10px; border: 1px solid black; background-color: #FF4500; margin-right: 5px;"></span> Cosmetics</li> <li><span style="display: inline-block; width: 10px; height: 10px; border: 1px solid black; background-color: #90EE90; margin-right: 5px;"></span> Flowers</li> <li><span style="display: inline-block; width: 10px; height: 10px; border: 1px solid black; background-color: #FFA500; margin-right: 5px;"></span> PPE</li> </ul> |
|---|--|

**Location**

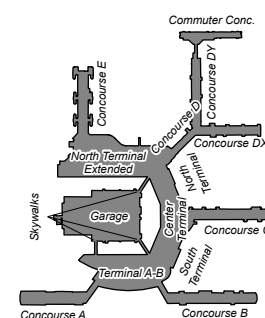

Date: 2021-12-14

**Consolidated Rental Car Facility, Ground Level**



**RFP-MDOT-AC-2023**

**Exhibit E**

**Concession Operational and Storage Areas**

**Sheet 11 of 11**